

QUICK START GUIDE FOR F7



Items included when your package arrives;

- Fingerprint terminal (F7).
- Screwdriver Tool
- Quick start Guide

Important Notes

- Do not place the F7 outdoors without adequate protection from weather.
- Do not place the F7 under strong light.
- Use regulated 12V DC 1.5A power source (supplied from door control panel or separately purchased power supply).
- Do not place the F7 in a vulnerable location where it might be subjected to weather, vandalism, etc.

Mounting the Unit

- Locate the appropriate area for the unit. Place the unit approximately 5 ½ feet above the ground level so that the users are comfortable in using the unit with fewer chances of errors.
- Create conduits for the power and network cable on the wall so that the unit receives the connections from the back of the wall.
- Remove the screw at the bottom of the unit when held vertically as shown in the picture below:



- This will remove the back plate of the unit.
- Install the back plate of the unit on to the wall and connect the power and network cables from behind the back plate.
- Secure the front of the unit on the back plate by reinstalling the removed screw from the bottom of the unit earlier.

Hardware Setup

- Power on the unit by supplying 12V DC to the PWR and GND pins on the back of the unit. The power supply is not supplied with the unit. Please make sure that the power requirements are strictly met to avoid permanent damage to the unit.

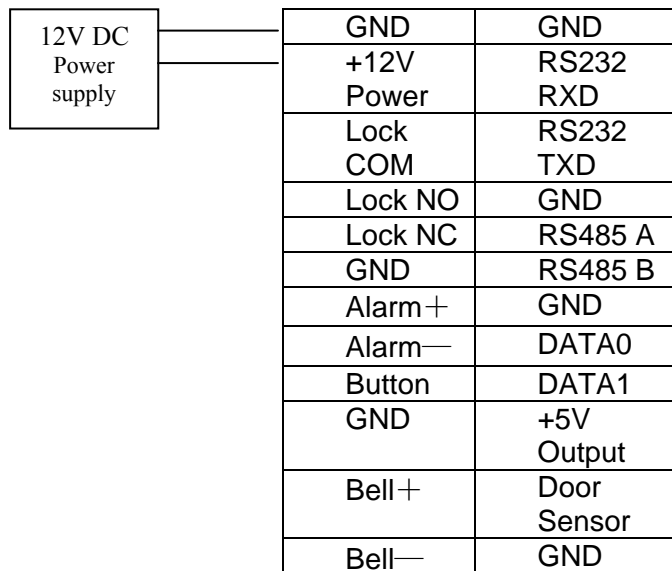

- After the Power on self test the ACT FP will show the date, day and time.

Date and Time Setup

To change the date and time, press the **M** (Menu) key;



The Menu will then display.

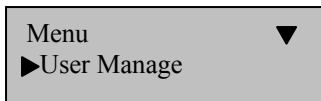

Scroll with the ▲/▼ keys and place the cursor (▶) alongside “Options”. Press the **OK** key.

Scroll with the ▲/▼ keys and place the cursor (▶) alongside “System Opt”. Press the **OK** key.

Scroll with the ▲/▼ keys and place the cursor (▶) alongside “Date Time”. Press the **OK** key.

Once in the **YYYY-MM-DD 24H** screen, use the scroll ▲/▼ keys to move between data fields.

Set the date and time.

Press the **OK** key to accept changes.

Press the **C** (cancel) key to cancel changes.

Fingerprint Enrollment:

Users (not including Admins, Supervisors or Enrollers) have NO “administrative” access to the F7, but can gain door access and have his/her attendance recorded.

Note:

Until an actual “Administrator” is enrolled in the F7, ALL “users” enrolled on the F7 have “temporarily” have administrative access. Therefore it is important to enroll an “administrator” on the F7 soon after initial installation.

“Users” can enroll with three methods;

- **Fingerprints**
- **Passwords**
- **Fingerprints and Passwords**

Enroll Fingerprint (for Users)

To start Fingerprint enrollment, press the **M** (Menu) key on the F7.



Scroll with the ▲/▼ keys and place the cursor (▶) alongside “User Manage”

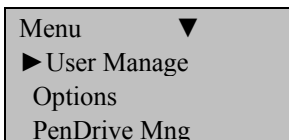

Press the **OK** key.



Scroll with the ▲/▼ keys and place the cursor (▶) alongside “Enroll User”.

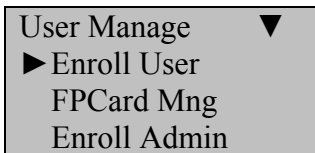

Press the **OK** key.

Scroll with the ▲/▼ keys and place the cursor (▶) alongside “Enroll FP”.

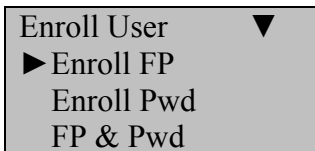

Press the **OK** key.

The F7 will prompt you;

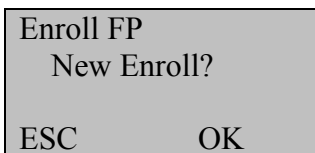

If this is a NEW User, then press **OK**

The F7 will then prompt you with the next available User ID

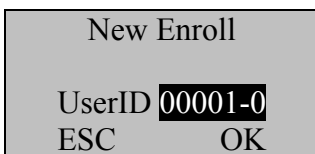

If no user has yet been enrolled on the F7, the next available User ID# will be 00001.

Press the **OK** key to accept 00001, or manually key in a different number if desired.

The F7 will then prompt;

```
New Enroll
00001-0
Place Finger . . .
ESC/Exit
```

Remember the rules for proper finger placement:

The user's finger should completely cover the sensor. The finger should be placed flat and in the center of the sensor. The finger should cover at least 80% of the sensor as shown below:

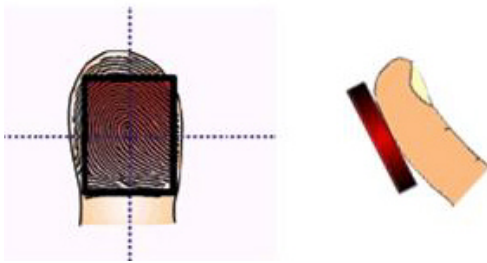

The finger should NOT be placed in the following positions:

Not flat

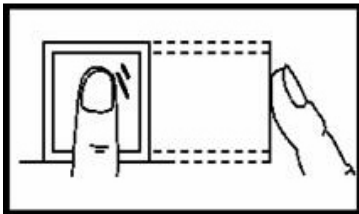

Not centered

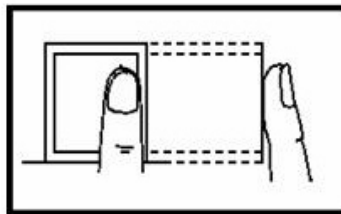

Not flat

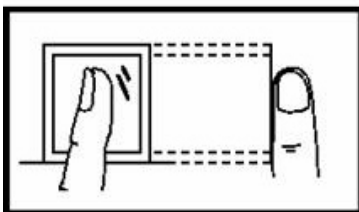

Not centered

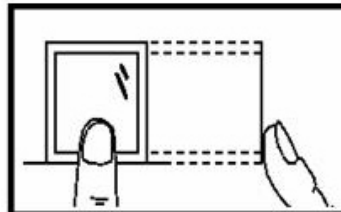

Place your finger on the sensor for a full 2 seconds.



After the F7 scans your fingerprint successfully, it will “beep” and then prompt you briefly with;

New Enroll
00001-1
Remove Finger
ESC/Exit

Then you’ll be prompted;

New Enroll
00001-1
Second Press
ESC/Exit

Remove your finger, and then place your finger on the sensor a 2nd time. Again, you’ll be prompted briefly;

New Enroll
00001-1
Remove Finger
ESC/Exit

Remove your finger, and then place your finger on the sensor a 3rd and final time. You’ll then be prompted;

New Enroll
00001-0
ESC OK (Save)

Press the **OK** key to accept the newly enrolled finger.

UserID 0001 has now been successfully enrolled with one fingerprint.

The F7 will then prompt you with;

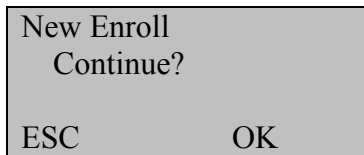

If you wish to continue enrolling additional users, press the **OK** key and follow the same procedures.

If you're finished enrolling additional users, press the **C** (Cancel/ESC) key.

When pressing **C** (Cancel/ESC) key, the F7 will prompt you;

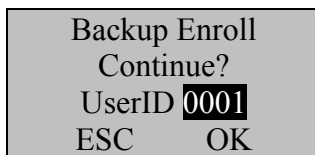

If you wish to add a “backup finger” for UserID 00001 press the **OK** key.

Note:

Ideally, we recommend enrolling two fingers of each hand so that in case of injury of one hand the user can use the finger of the other hand as a backup. It is recommended to enroll left or right index finger and left middle or right middle fingers.

After enrolling one or more fingerprints to UserID 00001 press the **C** (Cancel/ESC) key.

You'll note pressing the **C** (Cancel/ESC) key takes you back to the previous menu;

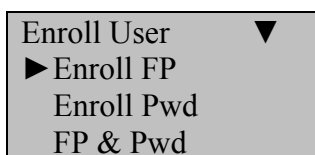

Press **C** (Cancel/ESC)

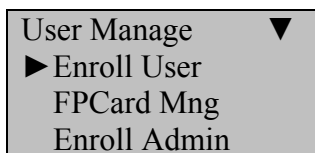

Press **C** (Cancel/ESC)

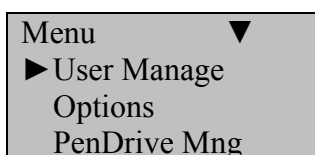

Continue pressing the **C** (Cancel/ESC) key until you return to the Start-Up window;

Welcome Check-In
HH:MM
MM/DD/YY DAY

Note:

The actual current date/time will appear.

Test the newly enrolled fingerprint by having UserID 0001 place his/her finger on the sensor.

If successful, the F7 will prompt with an audible “*Thank you*”, and the screen will display;

Verify

Pin: **00001**
Verified.

Note:

The F7 will make a note in its transaction log that User ID 0001 accessed the F7. This information can be used for Time & Attendance software applications and/or for door access.

Note:

If the fingerprints of certain users are unable to be enrolled successfully, you may use the **Enroll Pwd** (instead of **Enroll FP**) option for those users.

This will allow the user to choose a password/PIN# (up to 4 digits) instead of his/her fingerprint (similar to how a cash machine/ATM works).

Once all the users are enrolled, it’s advised to enroll a system **Administrator**.

Once an Administrator is enrolled, normal users will no longer be able to access the Menu and make unauthorized changes.

The enrollment procedure for Admin(s) is the same as for user(s). But instead of selecting **Enroll User**, scroll down and select **Enroll Admin**, instead.

Press the **M** (Menu) key to begin;

Scroll with the **▲/▼** keys and place the cursor (**▶**) alongside “**User Manage**”. Press **OK**.

Scroll with the **▲/▼** keys and place the cursor (**▶**) alongside “**Enroll Admin**”. Press **OK**.

Scroll with the **▲/▼** keys and place the cursor (**▶**) alongside “**Enroll FP**”. Press **OK**

Press **OK** to accept the default User ID, or manually enter a preferred User ID and press **OK**

Remove Enrolled User

Press the **M** (Menu) key to begin;

Scroll with the ▲/▼ keys and place the cursor (▶) alongside “User Manage”. Press **OK**.

Scroll with the ▲/▼ keys and place the cursor (▶) alongside “Delete”. Press **OK**.

Enter the User ID of the user you wish to delete. Press **OK**

The F7 will prompt you to confirm you wish to delete the fingerprint(s). Press **OK**

The F7 will prompt you to confirm you wish to delete the User. Press **OK**

The F7 will prompt you to confirm you wish to delete the User again. Press **OK**

Set Communications Options:

Press the **M** (Menu) key to begin

Scroll with the ▲/▼ keys and place the cursor (▶) alongside “Options”. Press **OK**.

Scroll with the ▲/▼ keys and place the cursor (▶) alongside “Comm Opt”. Press **OK**.

Available communication options will display;

- IP Address
- NetMask
- Gateway
- Net Speed
- Baud Rate
- Dev Num
- RS232
- RS 485
- COMM Key

Scroll with the ▲/▼ keys and place the cursor (▶) alongside the desired Comm option.

Press **OK**.

Enter additional Communication settings, each time pressing **OK** to accept.

Note:

Set the *Dev num* as 1

If you have more than one terminal being installed, make sure each terminal has a unique device number.

Set the *IP Addr* for the F7 if you are using TCP/IP connectivity.

Record the IP address of each F7 you've installed.
These IP addresses are used to identify the F7s.

If using Serial communication then match the F7's Baud Rate with the serial port of the connecting computer.